

Anschlagtechnik



NV 6 SPK Ringschraube, drehbar

Produktinformationen:

- Mit Güteklasse 10 eine Alternative zur klassischen Ringschraube DIN 580.
- Auch bei angezogener Schraube richtet sich die Ringschraube SPK unter Last in Lastrichtung aus.
- Einsetzbar bei -40°C bis +400 °C (Reduzierung Tragfähigkeit bis 300 °C auf 90% und bis 400 °C auf 75%).

Abmessungen:

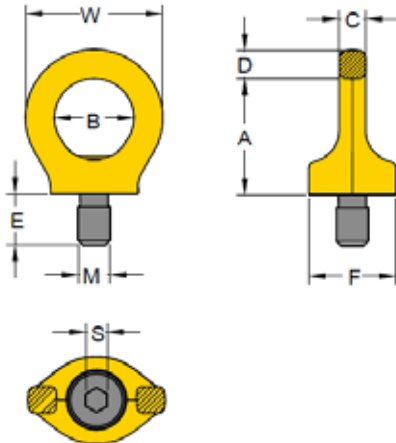

Lastrichtungen:



Bestellnummer	Gewinde	Maße (mm)								Tragfähigkeit (kg)		Gewicht (kg)
		A	B	C	D	E	F	S	W	X	Z	
NV 6 SPK03.8	M8x1,25	36	25	8	11	12	25	6	44	300	1000	0,1
NV 6 SPK04.10	M10x1,50	36	25	8	11	15	25	6	44	400	1000	0,1
NV 6 SPK07.12	M12x1,75	42	30	10	13	18	33	8	52	750	2000	0,2
NV 6 SPK15.16	M16x2,00	51	35	14	13	24	35	10	61	1500	4000	0,3
NV 6 SPK23.20	M20x2,50	57	40	16	17	30	44	12	70	2300	6000	0,5
NV 6 SPK32.24	M24x3,00	70	48	19	21	36	52	14	84	3200	8000	0,9
NV 6 SPK45.30	M30x3,50	86	60	24	26	45	62	17	108	4500	12000	1,7
NV 6 SPK70.36	M36x4,00	103	72	29	32	54	78	22	130	7000	16000	2,9
NV 6 SPK90.42	M42x4,50	120	82	34	38	63	88	24	150	9000	24000	4,6
NV 6 SPK120.48	M48x5,00	137	94	38	43	72	104	27	168	12000	32000	7,0
NV 6 SPK120.56	M56x5,50	147	102	40	43	84	124	27	178	12000	32000	9,2
NV 6 SPK120.64	M64x6,00	147	102	40	43	84	124	27	178	12000	32000	10,0

Tragfähigkeiten (in Tonnen):

Bestellnummer	1		2		2		2		3-4		3-4	
	0°	0°	90°	90°	0-45°	45-60°	unsymm.	0-45°	45-60°	unsymm.	unsymm.	
NV 6 SPK03.8	1,00	2,00	0,30	0,60	0,42	0,30	0,30	0,63	0,45	0,30	0,30	
NV 6 SPK04.10	1,00	2,00	0,40	0,80	0,56	0,40	0,40	0,80	0,60	0,40	0,40	
NV 6 SPK07.12	2,00	4,00	0,75	0,75	10,00	0,75	0,75	1,50	1,10	0,75	0,75	
NV 6 SPK15.16	4,00	8,00	1,50	1,50	2,10	1,50	1,50	3,10	2,20	1,50	1,50	
NV 6 SPK23.20	6,00	12,00	2,30	2,30	3,20	2,30	2,30	4,80	3,40	2,30	2,30	
NV 6 SPK32.24	8,00	16,00	3,20	3,20	4,50	3,20	3,20	6,70	4,80	3,20	3,20	
NV 6 SPK45.30	12,00	24,00	4,50	4,50	6,30	4,540	4,540	9,40	6,70	4,540	4,540	
NV 6 SPK70.36	16,00	32,00	7,00	7,00	9,80	7,00	7,00	14,70	10,50	7,00	7,00	
NV 6 SPK90.42	24,00	48,00	9,00	9,00	12,60	9,00	9,00	18,90	13,50	9,00	9,00	
NV 6 SPK120.48	32,00	64,00	12,00	12,00	16,80	12,00	12,00	25,00	18,00	12,00	12,00	
NV 6 SPK120.56	32,00	64,00	12,00	12,00	16,80	12,00	12,00	25,00	18,00	12,00	12,00	
NV 6 SPK120.64	32,00	64,00	12,00	12,00	16,80	12,00	12,00	25,00	18,00	12,00	12,00	

NV 6 RGB Ringbock

Produktinformationen:





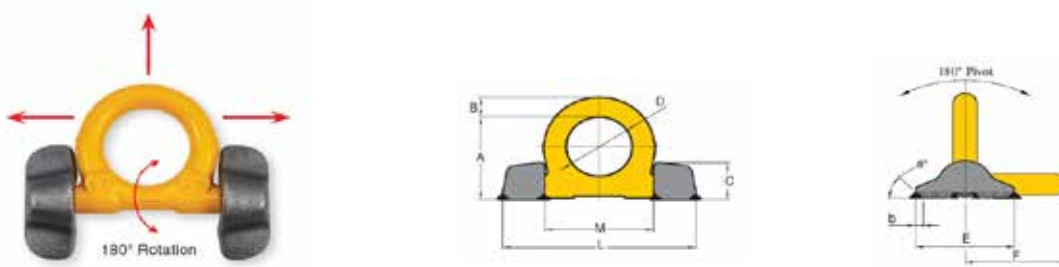



■ Güteklasse 10

Abmessungen:



Bestellnummer	Maße (mm)										Tragfähigkeit (kg)	Gewicht (kg)
	A	B	C	D	E	F	L	M	a°	b		
NV 6 RGB4000	66	14	30	48	65	70	135	76	45	5	4000	0,6
NV 6 RGB6700	85	20	39	60	89	91	11	98	45	5	6700	1,5
NV 6 RGB10000	95	21	46	65	100	100	196	106	45	7	10000	2,4
NV 6 RGB16000	127	30	57	90	130	136	263	149	45	8	16000	5,5
NV 6 RGB31500	178	42	78	130	160	195	375	213	45	15	31500	15,8

Tragfähigkeiten (in Tonnen):

Bestellnummer										
	1 0°	2 0°	1 90°	2 90°	2 0-45°	2 45-60°	2 unsymm.	3 - 4 0-45°	3 - 4 45-60°	3 - 4 unsymm.
NV 6 RGB4000	4,00	8,00	4,00	8,00	5,60	4,00	4,00	8,40	6,00	4,00
NV 6 RGB6700	6,70	13,40	6,70	13,40	9,40	6,70	6,70	14,10	10,10	6,70
NV 6 RGB10000	10,00	20,00	10,00	20,00	14,00	10,00	10,00	21,00	15,00	10,00
NV 6 RGB16000	16,00	32,00	16,00	32,00	22,40	16,00	16,00	33,60	24,00	16,00
NV 6 RGB31500	31,50	63,00	31,50	63,00	44,10	31,50	31,50	66,20	47,30	31,50

NV 6 LBO Lastbock

Produktinformationen:

- Alle Lastböcke erfüllen Anforderungen der Maschinenrichtlinie u. sind mit Zulassung und H-Stempel der BG.
- Alle Lastböcke haben Güteklasse 10 und erfüllen die Anforderungen der ASME B30.26.
- Temperaturbeständigkeit: $-40^{\circ}\text{C} - +100^{\circ}\text{C} = 100\%$ / bis $200^{\circ}\text{C} = 85\%$ / bis $250^{\circ}\text{C} = 80\%$ / bis $350^{\circ}\text{C} = 75\%$.

Abmessungen:

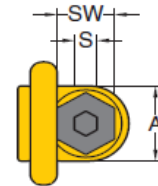
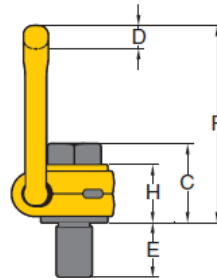







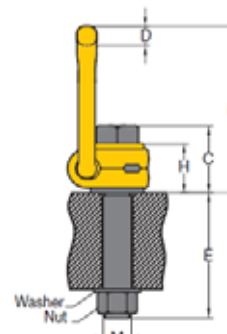

Bestellnummer	Gewinde	Maße (mm)										Tragfähigkeit (kg)	Gewicht (kg)	Drehmoment (Nm)	
		A	B	C	D	E	F	G	H	S	SW				
NV 6 LBO003.08*	M8x1,25	30	35	35	10	11	85	55	29	6	13	300	0,2	30	
NV 6 LBO006.10*	M10x1,50	30	35	36	10	16	85	55	29	6	17	630	0,3	60	
NV 6 LBO010.12*	M12x1,75	33	37	44	14	18	98	57	36	8	19	1000	0,5	100	
NV 6 LBO012.14	M14x2,00	33	37	45	14	21	98	57	36	10	22	1200	0,5	120	
NV 6 LBO015.16*	M16x2,00	33	37	46	14	24	98	57	36	10	24	1500	0,5	150	
NV 6 LBO020.18	M18x2,00	50	54	57	17	26	140	82	44	12	30	2000	1,3	200	
NV 6 LBO025.20*	M20x2,50	50	54	57	17	30	140	82	44	12	30	2500	1,3	250	
NV 6 LBO040.24*	M24x3,00	50	54	59	17	36	140	82	44	14	36	4000	1,4	400	
NV 6 LBO040.27	M27x3,00	60	65	79	23	38	170	99	62	17	41	4000	2,8	400	
NV 6 LBO050.30*	M30x3,50	60	65	81	23	48	170	99	62	17	46	5000	3,1	500	
NV 6 LBO070.36*	M36x4,00	60	65	88	23	54	178	99	65	22	55	7000	3,3	700	
NV 6 LBO080.36	M36x4,00	77	85	101	27	62	225	124	78	22	55	8000	5,8	800	
NV 6 LBO100.42*	M42x4,50	77	85	104	27	72	225	124	78	24	65	10000	6,3	1000	
NV 6 LBO150.42*	M42x4,50	95	104	112	36	57	256	158	86	24	65	15000	10,8	1500	
NV 6 LBO200.48*	M48x5,00	95	104	120	36	72	259	158	90	27	75	20000	11,6	2000	
NV 6 LBO220.56															
NV 6 LBO225.64															

* Die gekennzeichneten Lastböcke sind auch mit langer Schrauber erhältlich. Das Maß E ist bis E_{\max} bestellbar. Die Tragfähigkeiten sind äquivalent zum Lastbock mit kurzer Schraube.

Bestellnummer NV 6 LBOL	E_{\max}	Gewicht (kg)
NV 6 LBOL003.08	76	0,30
NV 6 LBOL006.10	96	0,40
NV 6 LBOL010.12	114	0,60
NV 6 LBOL015.16	149	0,70
NV 6 LBOL025.20	186	1,70
NV 6 LBOL040.24	221	2,10
NV 6 LBOL050.30	278	4,30
NV 6 LBOL080.36	222	7,30
NV 6 LBOL100.42	272	8,70
NV 6 LBOL150.42	264	13,10
NV 6 LBOL200.48	295	15,20



Tragfähigkeiten (in Tonnen):

Bestellnummer										
	1	2	1	2	2	2	3 - 4	3 - 4		
	0°	0°	90°	90°	0-45°	45-60°	unsymm.	0-45°	45-60°	unsymm.
NV 6 LBO003.08	0,30	0,60	0,30	0,60	0,42	0,30	0,30	0,63	0,45	0,30
NV 6 LBO006.10	0,63	1,26	0,63	1,26	0,88	0,63	0,63	1,32	0,95	0,63
NV 6 LBO010.12	1,00	2,00	1,00	2,00	1,40	1,00	1,00	2,10	1,50	1,00
NV 6 LBO012.14	1,20	2,40	1,20	2,40	1,70	1,20	1,20	2,50	1,80	1,20
NV 6 LBO015.16	1,50	3,00	1,50	3,00	2,10	1,50	1,50	3,10	2,20	1,50
NV 6 LBO020.18	2,00	4,00	2,00	4,00	2,80	2,00	2,00	4,20	3,00	2,00
NV 6 LBO025.20	2,50	5,00	2,50	5,00	3,50	2,50	2,50	5,20	3,70	2,50
NV 6 LBO040.24	4,00	8,00	4,00	8,00	5,60	4,00	4,00	8,40	6,00	4,00
NV 6 LBO040.27	4,00	8,00	4,00	8,00	5,60	4,00	4,00	8,40	6,00	4,00
NV 6 LBO050.30	5,00	10,00	5,00	10,00	7,00	5,00	5,00	10,50	7,50	5,00
NV 6 LBO070.36	7,00	14,00	7,00	14,00	9,80	7,00	7,00	14,70	10,50	7,00
NV 6 LBO080.36	8,00	16,00	8,00	16,00	11,20	8,00	8,00	16,80	12,00	8,00
NV 6 LBO100.42	10,00	20,00	10,00	20,00	14,00	10,00	10,00	21,00	15,00	10,00
NV 6 LBO150.42	15,00	30,00	15,00	30,00	21,00	15,00	15,00	31,50	22,50	15,00
NV 6 LBO200.48	20,00	40,00	20,00	40,00	28,00	20,00	20,00	42,00	30,00	20,00

Reparatursets sind auf Anfrage erhältlich.





NV 6 SPO **NEU**

Wirbelbock 2. Generation

Bestellnummer	Gewinde metrisch	Maße (mm)									Tragfähigkeit(t)		M (Nm)	m (kg)	VPE
		A	B	C	D	E	F	G	H	K	y	z			
NV 6 SPO004.01	M8x1,25	35	53	48	13	12	101	36,5	20,5	34	0,3	0,6	10-40	0,3	50
NV 6 SPO007.01	M10x1,50	35	53	48	13	18	101	36,5	20,5	34	0,5	1,0	10-40	0,4	60
NV 6 SPO007.02	M12x1,75	35	53	48	13	18	101	36,5	20,5	34	0,7	1,4	15-40	0,4	60
NV 6 SPO007.03	M12x1,75	35	53	48	13	25	101	36,5	20,5	34	0,7	1,4	15-40	0,4	50
NV 6 SPO007.04	M14x2,00	35	53	48	13	20	101	36,5	20,5	34	1,0	2,0	30-40	0,4	50
NV 6 SPO014.01	M16x2,00	35	53	48	13	20	101	36,5	20,5	34	1,4	2,8	45-130	0,44	50
NV 6 SPO014.02	M16x2,00	35	53	48	13	24	101	36,5	20,5	34	1,4	2,8	45-130	0,5	40
NV 6 SPO014.03	M16x2,00	35	53	48	13	30	101	36,5	20,5	34	1,4	2,8	45-130	0,5	40
NV 6 SPO014.04	M20x2,50	35	53	48	13	30	101	36,5	20,5	34	1,7	3,4	75-130	0,5	40
NV 6 SPO014.05	M24x3,00	35	53	48	13	30	101	36,5	20,5	34	1,7	3,4	90-130	0,5	40
NV 6 SPO025.01	M20x2,50	35	59	68	16	30	127	52	28	46	2,5	5,0	100-170	1,0	20
NV 6 SPO025.02	M20x2,50	35	59	68	16	40	127	52	28	46	2,5	5,0	100-170	1,0	20
NV 6 SPO025.03	M20x2,50	35	59	68	16	50	127	52	28	46	2,5	5,0	100-170	1,1	20
NV 6 SPO025.04	M20x2,50	35	59	68	16	70	127	52	28	46	2,5	5,0	100-170	1,1	20
NV 6 SPO040.01	M24x3,00	40	73	75	19	30	148	57	34,5	50	4,0	8,0	190-280	1,5	12
NV 6 SPO040.02	M24x3,00	40	73	75	19	36	148	57	34,5	50	4,0	8,0	190-280	1,5	12
NV 6 SPO040.03	M24x3,00	40	73	75	19	45	148	57	34,5	50	4,0	8,0	190-280	1,5	12
NV 6 SPO040.04	M24x3,00	40	73	75	19	50	148	57	34,5	50	4,0	8,0	190-280	1,5	12
NV 6 SPO040.05	M30x3,50	40	73	75	19	35	148	57	34,5	50	4,0	8,0	190-280	1,5	12
NV 6 SPO067.01	M30x3,50	40	68	95	19	35	163	70	41	65	6,7	12,0	230-400	2,4	10
NV 6 SPO067.02	M30x3,50	40	68	95	19	45	163	70	41	65	6,7	12,0	230-400	2,4	10
NV 6 SPO067.03	M30x3,50	40	68	95	19	50	163	70	41	65	6,7	12,0	230-400	2,5	8
NV 6 SPO067.04	M30x3,50	40	68	95	19	60	163	70	41	65	6,7	12,0	230-400	2,5	8
NV 6 SPO080.01	M30x3,50	50	95	106	22	35	201	81	48	75	8,0	12,0	270-600	3,6	6
NV 6 SPO080.02	M30x3,50	50	95	106	22	45	201	81	48	75	8,0	12,0	270-600	3,7	6
NV 6 SPO100.01	M36x4,00	50	95	106	22	50	201	81	48	75	10,0	15,0	270-600	3,8	6
NV 6 SPO100.02	M36x4,00	50	95	106	22	54	201	81	48	75	10,0	15,0	270-600	3,9	6
NV 6 SPO125.01	M42x4,50	50	95	106	22	50	201	81	48	75	12,5	15,0	270-700	3,9	6
NV 6 SPO125.02	M42x4,50	50	95	106	22	60	201	81	48	75	12,5	15,0	270-700	4,0	5
NV 6 SPO125.03	M42x4,50	50	95	106	22	63	201	81	48	75	12,5	15,0	270-700	4,0	5
NV 6 SPO125.04	M45x4,50	50	95	106	22	60	201	81	48	75	12,5	15,0	270-700	4,1	5
NV 6 SPO125.05	M48x5,00	50	95	106	22	72	201	81	48	75	12,5	15,0	270-700	4,4	5
NV 6 SPO170.01	M42x4,50	70	129	127	32	60	256	104	58	95	13,0	20,0	350-800	7,4	3
NV 6 SPO170.02	M45x4,50	70	129	127	32	60	256	104	58	95	17,0	25,0	350-800	7,5	3
NV 6 SPO170.03	M48x5,00	70	129	127	32	60	256	104	58	95	17,0	25,0	350-800	7,6	3
NV 6 SPO170.04	M48x5,00	70	129	127	32	72	256	104	58	95	17,0	25,0	350-800	7,7	3
NV 6 SPO170.045	M52x5,00	70	129	127	32	78	256	104	58	95	17,0	25,0	350-800	7,9	2
NV 6 SPO170.05	M56x5,50	70	129	127	32	78	256	104	58	95	18,0	25,0	350-900	8,1	2
NV 6 SPO170.06	M56x5,50	70	129	127	32	84	256	104	58	95	18,0	25,0	350-900	8,1	2
NV 6 SPO200.01	M64x6,00	70	129	127	32	96	256	104	58	95	20,0	25,0	350-900	8,9	2
NV 6 SPO200.02	M64x6,00	70	129	127	32	110	256	104	58	95	20,0	25,0	350-900	9,3	2
NV 6 SPO280.01	M64x6,00	80	131	174	36	96	305	129	78	115	28,0	32,5	500-1000	16,4	1
NV 6 SPO280.02	M72x6,00	80	131	174	36	120	305	129	78	115	28,0	32,5	500-1200	17,7	1
NV 6 SPO280.03	M80x6,00	80	131	174	36	150	305	129	78	115	28,0	32,5	500-1200	19,6	1
NV 6 SPO350.005	M72x6,00	100	179	187	45	108	366	148	85	135	35,0	40,0	500-1400	24,8	1
NV 6 SPO350.01	M80x6,00	100	179	187	45	120	366	148	85	135	35,0	40,0	500-1400	25,3	1
NV 6 SPO350.02	M90x6,00	100	179	187	45	150	366	148	85	135	35,0	40,0	500-1500	27,8	1
NV 6 SPO400.01	M80x6,00	90	130	210	45	120	340	170	83	145	40,0	50,0	500-1500	31,9	1
NV 6 SPO400.02	M90x6,00	90	130	210	45	115	340	170	83	145	40,0	50,0	500-1500	33,6	1
NV 6 SPO400.03	M90x6,00	90	130	210	45	150	340	170	83	145	40,0	50,0	500-1500	34,2	1
NV 6 SPO400.04	M100x6,00	90	130	210	45	150	340	170	83	145	40,0	50,0	500-1700	35,2	1

Abmessungen:



230° schwenkbar

360° drehbar

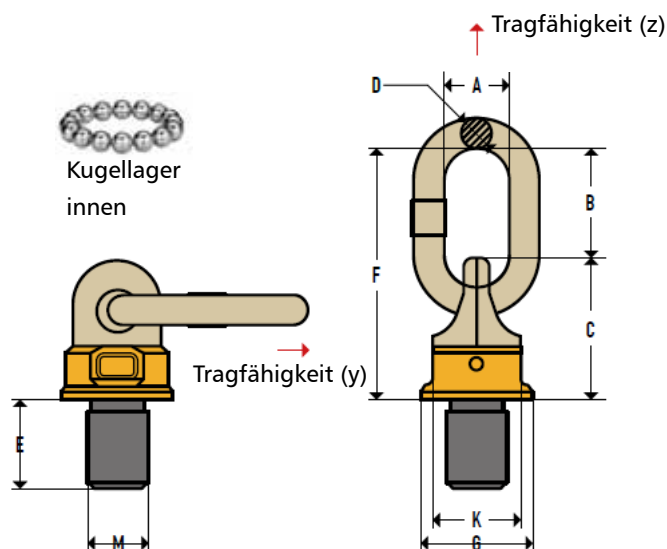
Kugellager
innen

Tragfähigkeit (y)

Tragfähigkeit (z)

- Erfüllt die Leistungsanforderungen der ASME B30.26; getestet nach EN 1677-4 mit 2,5 facher Sicherheit.
- Der Wirbelbock NV 6 SPO ersetzt ab sofort den Wirbelbock NV 6 WBO.
- **ACHTUNG: Es gibt Abweichungen hinsichtlich Belastbarkeit und Gewindetiefe!**
- **ACHTUNG: Niemals die angegebene Tragfähigkeit überschreiten!**

Tragfähigkeiten (in Tonnen):

Bestellnummer											
		1 0°	2 0°	1 90°	2 90°	0-45°	45-60°	2	0-45°	45-60°	3-4 unsymm.
NV 6 SPO 004	M8	0,6	1,2	0,4	0,8	0,6	0,4	0,4	0,8	0,6	0,6
NV 6 SPO 007	M10	1,0	2,0	0,5	1,0	0,7	0,5	0,5	1,0	0,75	0,75
	M12	1,4	2,8	0,7	1,4	1,0	0,7	0,7	1,4	1,0	1,0
	M14	2,0	4,0	1,0	2,0	1,4	1,0	1,0	2,12	1,5	1,5
NV 6 SPO 014	M16	2,8	5,6	1,4	2,8	2,0	1,4	1,4	3,0	2,12	2,12
	M20	3,4	6,8	1,7	3,4	2,4	1,7	1,7	3,55	2,5	2,5
	M24	3,4	6,8	1,7	3,4	2,4	1,7	1,7	3,55	2,5	2,5
NV 6 SPO 025	M20	5,0	10,0	2,5	5,0	3,55	2,5	2,5	5,3	3,75	3,75
NV 6 SPO 040	M24	8,0	16,0	4,0	8,0	5,6	4,0	4,0	8,5	6,0	6,0
	M30	8,0	16,0	4,0	8,0	5,6	4,0	4,0	8,5	6,0	6,0
NV 6 SPO 067	M30	12,0	24,0	6,7	13,4	9,5	6,7	6,7	14,0	10,0	10,0
NV 6 SPO 080	M30	12,0	24,0	8,0	16,0	11,2	8,0	8,0	16,0	12,0	12,0
NV 6 SPO 100	M36	15,0	30,0	10,0	20,0	14,0	10,0	10,0	21,2	15,0	15,0
NV 6 SPO 125	M42	15,0	30,0	12,5	25,0	17,0	12,5	12,5	25,0	18,0	18,0
	M45	15,0	30,0	12,5	25,0	17,0	12,5	12,5	25,0	18,0	18,0
	M48	15,0	30,0	12,5	25,0	17,0	12,5	12,5	25,0	18,0	18,0
NV 6 SPO 170	M42	20,0	40,0	13,0	26,0	18,0	13,0	13,0	27,0	19,0	19,0
	M45	25,0	50,0	17,0	34,0	23,5	17,0	17,0	35,0	25,0	25,0
	M48	25,0	50,0	17,0	34,0	23,5	17,0	17,0	35,0	25,0	25,0
	M56	25,0	50,0	18,0	36,0	25,0	18,0	18,0	37,5	26,5	26,5
NV 6 SPO 200	M64	25,0	50,0	20,0	40,0	28,0	20,0	20,0	42,5	30,0	30,0
NV 6 SPO 280	M64	32,5	65,0	28,0	56,0	39,0	28,0	28,0	58,0	42,0	42,0
	M72	32,5	65,0	28,0	56,0	39,0	28,0	28,0	58,0	42,0	42,0
	M80	32,5	65,0	28,0	56,0	39,0	28,0	28,0	58,0	42,0	42,0
NV 6 SPO 350	M80	40,0	80,0	35,0	70,0	49,0	35,0	35,0	74,0	52,5	52,5
	M90	40,0	80,0	35,0	70,0	49,0	35,0	35,0	74,0	52,5	52,5
NV 6 SPO 400	M80	50,0	100,0	40,0	80,0	56,0	40,0	40,0	84,0	60,0	60,0
	M90	50,0	100,0	40,0	80,0	56,0	40,0	40,0	84,0	60,0	60,0
	M100	50,0	100,0	40,0	80,0	56,0	40,0	40,0	84,0	60,0	60,0

NV 6 AK Anschlagketten



Ketten Güteklasse 8 und Zubehör:

Maße (mm)			Tragfähigkeit (kg)	Gewicht (kg/m)
d	t	b		
6	18	21	1120	0,80
7	21	24	1500	1,10
8	24	28	2000	1,40
10	30	35	3150	2,20
13	39	46	5300	3,80
16	48	57	8000	5,70
18	54	64	10000	7,30
20	60	70	12500	9,00
22	66	78	15000	10,90
26	78	91	21200	15,20
32	96	115	31500	23,00

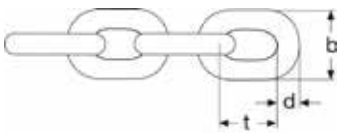

- Aufhängeglied für 1-Strangkettens mit/ohne Flachstelle
- Aufhängeglied für 2-Strangkettens mit/ohne Flachstelle
- Kopfgehänge dreiteilig mit/ohne Flachstelle
- Verbindungsglied
- Ösenhaken
- Gabelkopfhaken
- Sicherheitshaken mit Öse
- Sicherheitshaken mit Gabelkopf
- Wirbelhaken mit Gleitlager
- Weitmaulhaken mit Öse
- Choker Haken
- Gabelhaken
- Verkürzungshaken mit Öse
- Verkürzungshaken mit Gabel
- Anschlagpunkte
- Rundschlingenhaken
- Gabelverbinder
- Sicherungsfalle für Haken mit Stift und Feder
- Markierungsanhänger ein- und mehrsträngig

Ketten Güteklasse 10 und Zubehör:

Maße (mm)			Tragfähigkeit (kg)	Gewicht (kg/m)
d	t	b		
6	18	21	1400	0,80
7	21	24	1900	1,10
8	24	28	2500	1,40
10	30	35	4000	2,20
13	39	46	6700	3,80
16	48	57	10000	5,70
20	60	70	16000	9,00
22	66	78	19000	10,90
26	78	91	26500	15,20
32	96	115	40000	23,00

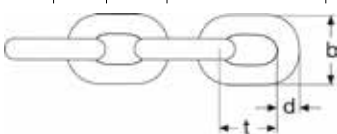

- Aufhängeglied für 1-Strangkettens mit/ohne Flachstelle
- Aufhängeglied für 2-Strangkettens mit/ohne Flachstelle
- Kopfgehänge dreiteilig mit/ohne Flachstelle
- Aufhängung für Einstrangkettens ohne Flachstelle
- Aufhängung für Zweistrangkettens ohne Flachstelle
- Verbindungsglied
- Ösenhaken
- Gabelkopfhaken
- Sicherheitshaken mit Öse
- Sicherheitshaken mit Gabel
- Sicherheitshaken mit Wirbel (Kugellager oder Messingbuchse)tlager
- Weitmaulhaken mit Gabel oder Öse
- Verkürzungshaken mit Öse, Gabel oder ohne Auflage
- Ösenhaken für Hebezeuge
- Wirbelhaken für Hebezeuge
- Gurtverbinder und Gurthaken
- Sicherheitshaken mit Gurtanschluss
- Sicherheitshaken (Öse und Griff)
- Sicherheitshaken (Gabel und Griff)
- Sicherheitshaken (Wirbel und Griff)

Bei Fragen zu Anschlagketten sowie Preise und Lieferzeiten setzen Sie sich bitte mit uns in Verbindung.